

Montageanleitung

501 Design

- CZ** Návod k instalaci
- DK** Montagevejledning
- E** Instrucciones de montaje
- F** Instructions de montage
- GB** Installation instructions
- GR** Οδηγία συναρμολόγησης
- H** Szerelési utasítás
- I** Istruzioni di montaggio
- NL** Montagehandleiding
- NO** Installasjonsanvisning
- P** Instrução de montagem
- PL** Instrukcja montażu
- RU** Указания по установке
- S** Monteringsanvisning
- SF** Asennusohje
- SK** Návod na montáž
- SLO** Navodila za montažo
- TR** Montaj talimatı

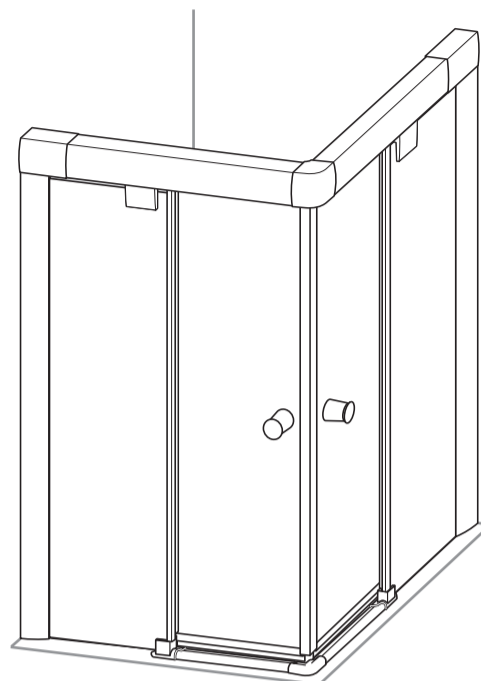

HÜPPE
SHOWER SOLUTIONS

00.510.813.02

- D** **Wichtiger Hinweis:**
Bitte prüfen Sie die Duschabtrennung vor dem Einbau auf Transportschäden und Vollständigkeit. Nach dem Einbau können Beanstandungen nicht mehr anerkannt werden.
- CZ** **Důležité upozornění:**
Před instalací sprchové kabiny přezkontrolujte, prosím, zda nebyla kabina během přepravy poškozena a zda je dodávka kompletní. Po zabudování nemůže být reklamace již uznána.
- GR** **Βιγτίγ οπλυσνίγ:**
Ινδεν καβινεβάγγγεν μοντερες, undersøges den for transportskader o.lign., idet reklamationer ikke kan godkendes efter at montering har fundet sted.
- E** **Nota importante:**
Por favor, antes de montar la mampara se debe controlar que el producto no haya sufrido daños durante el transporte y que todas las piezas estén completas. Una vez instalado el artículo no asumiremos ninguna responsabilidad por las eventuales reclamaciones.
- F** **Remarque importante:**
avant de procéder au montage, vérifiez que le pare-douche est complet et qu'il n'a pas été endommagé lors du transport. Aucune réclamation ne pourra être admise après le montage.
- GB** **Important information:**
Please check the shower enclosure for transport damage and completeness before installation. Complaints made following installation cannot be accepted.
- GR** **Σημαντική υποδείξη:**
Παρακαλούμε ελεγγατε την διαχωριστική ντουζερια πριν την συναρμολόγηση σχετικά με φθορες εκ μεταφοράς και πληροτητα. Μετα το μονταρισμα δεν αναγγωρίζονται πλέον οι σχετικές διαμαρτυρίες.
- H** **Fontos tudnivaló:**
Kérjük, beépítés előtt ellenőrizze a zuhanyleválasztót, hogy a szállításnál nem sérült-e és hogy hiánytalan-e. A beépítés után már nem fogadunk el reklamációt.
- I** **Avviso importante:**
Prima di effettuare il montaggio vi preghiamo di controllare se la parete divisoria della doccia presenta dei danni di trasporto. Dopo il montaggio non vengono più accettati reclami.
- NL** **Belangrijk:**
Controleer voor het inbouwen of het douchescherm bij het transport beschadigd is en of het volledig is. Na het inbouwen kunnen klachten niet meer in behandeling genomen worden.
- NO** **Viktig informasjon:**
Vennligst sjekk dusjkabinetet for transportskader og at det er komplett før installasjon. Klager som gjøres etter installasjon kan ikke aksepteres.
- P** **Indicação importante:**
Favor verificar antes da instalação se a separação de chuveiro está completa e se sofreu danos de transporte. Depois da montagem não se aceitam reclamações.
- PL** **Ważna wskazówka:**
Przed zabudowaniem przysznycowej ścianki działowej należy sprawdzić jej kompletność i skontrolować na obecność ewentualnych uszkodzeń powstałych w czasie transportu. Po dokonaniu zabudowy reklamacje nie będą uwzględniane.
- RU** **Важная информация:**
Перед сборкой проверьте душевую кабину на наличие повреждений и ее укомплектованность. Претензии после сборки не принимаются.
- S** **Viktig hänvisning:**
Innan duschskiljeväggen byggs in måste man kontrollera att inga transportskador uppkommit på den och att den är fullständig. När den byggs in kan inte några reklamationer accepteras längre.
- SF** **Tärkeä ohje:**
Tarkista suihkuseinäke ennen asennusta kuljetusvauroiden varalta ja tarkista myös toimituksen sisältö. Asennuksen jälkeen ei valituksia enää voida ottaa huomioon.
- SK** **Dôležitě upozornenie:**
Pred abudovaním oddeovacej sprchovacej steny skontrolujte prosím, i nebola pokodená počas prepravy a i je dodávka úplná. Po zabudovaní sa reklamácie u neuznávajú.
- SLO** **Važen nasvet:**
Pred montažo preverite, e je bila kabina za prhanje na prevozu poškodovana in da je popolna. Reklamacije po konani montaži ne moremo ve upoštevati.
- TR** **Önemli açıklama:**
Du duvarını takmadan önce lütfen nakliyat hasarını ve eksiksiz olup olmadığını kontrol ediniz. Du duvarını takdıktan sonra yapılacak ikayetler kabul edilmez.

- D** **Sicherheitshinweis:**
Die Installation ist durch einen Fachmann durchzuführen. Hüppe Einscheibensicherheitsgläser dürfen nachträglich nicht bearbeitet werden. Stets die Kanten der Scheiben schützen, z. B. beim Abstellen der Scheiben immer Holz oder Pappe als Unterlage benutzen.
- CZ** **Bezpečnostní pokyny:**
Instalaci smí provést pouze odborník. Jednoduché bezpečnostní okenní tabule firmy Hüppe nesmí být dodatečně opracovávány. Hrany tabulí musí být neustále chráněny; používejte např. při stavění tabulí na hrany vždy dřevěnou nebo lepenkovou podložku.
- GR** **Σικκρηδσοπλυσνίγ:**
Installationen skal foretages af en fagmand, der råder over den fornødne ekspertise. Der må ikke foretages ændringer af Hüppe-sikkerhedsglas (enkeltrude). Sørg for at beskytte rudens kanter og brug træ eller karton som underlag, når De stiller den fra Dem.
- E** **Reglamento de seguridad:**
Es imprescindible que se efectúe la instalación debidamente por parte de un técnico especializado. Una vez instalados los vidrios de seguridad de Hüppe no se deben someter a manipulación posterior. Hay que observar siempre la protección de los cantos de los vidrios, al apoyar los vidrios en el suelo depositarlos p. e. sobre madera o cartón.
- F** **Remarques concernant la sécurité:**
l'installation doit être confiée à un professionnel. Vous ne devez en aucune façon tenter de retailer les vitrages Hüppe en verre sécurisé. Veillez à en protéger les bords, par exemple en utilisant du bois ou du carton comme support avant de les poser par terre.
- GB** **Safety information**
Installation must be carried out by trained personnel. Single-pane, safety glass panels from Hüppe must not be reworked in any way following supply. Always protect the edges of the panes, e.g. always set down on a strip of wood or card.
- GR** **Οδηγία ασφαλείας:**
Η εγκατάσταση να γίνεται από εξειδικευμένο μαστορά. Τα τζαμια ενός υαλοπινάκα ασφαλείας Χωππε απαγορεύεται να υφίστανται εκ των υστέρων επεξεργασία. Προστατεύετε πάντα τις κοχες των υαλοπινάκων, π. χ. κατά την εναποθέση των τζαμιών να χρησιμοποιείτε πάντα ξύλο ή χαπτονι σαν υποβάθρο βάσης.
- H** **Biztonsági tudnivalók:**
A beszerelést szakemberrel végeztesse! A Hüppe-féle egy rétegű biztonsági üvegből készült ajtókat nem szabad utólag megmunkálni. Az üvegek széleit mindig védje, pl. az üveg leállításánál mindig használjon alátétként fát vagy papírlémezt.
- I** **Conno sulla sicurezza:**
Il montaggio deve venire effettuato da un tecnico specializzato. Non è lecito eseguire lavorazioni successive sui vetri di sicurezza Hüppe a lastra singola. Proteggete sempre gli orli delle lastre, p. es. impiegate sempre del legno o della carta come appoggio per le lastre che vengono messe da parte.
- NL** **Veiligheidsvoorschrift:**
De installatie moet door een vakman worden uitgevoerd. Hüppe gehard veiligheidsglas mag niet achteraf worden bewerkt. Bescherm altijd de zijkanen van de ruit; gebruik bv. bij het plaatsen van de ruit altijd hout of karton als ondergrond.
- NO** **Sikkerhetsinformasjon:**
Installasjon må gjøres av opplært personell. Helplate sikkerhetsglass paneler fra Hüppe må ikke endres på noen måte etter levering. Beskytt alltid kantene av glasset, sett det f.eks. ned på et stykke tre eller papp.
- P** **Indicação de segurança:**
A instalação deve ser feita por um especialista. Os vidros de segurança de Hüppe não devem ser trabalhados ulteriormente. Proteger sempre os cantos dos vidros utilizando p.expl. madeira ou cartão como base para depositar o vidro.
- PL** **Wskazówka bezpieczeństwa:**
Instalację należy powierzyć fachowcowi. Jednowarstwowych szyb bezpiecznych firmy Hüppe nie należy poddawać dalszej obróbce. Przy odstawianiu szyb chronić krawędzie, np. przez ustawienie na drewnianej lub tekturowej podkładce.
- RU** **Информация по безопасности:**
Сборку должен производить подготовленный персонал. После поставки одиночные панели и панели из безопасного стекла фирмы Hüppe нельзя каким-либо образом переделывать. Обеспечивайте постоянную защиту кромок панелей, напр., всегда устанавливайте их на брус или картон.
- S** **Säkerhetsupplysning:**
Installationen ska genomföras av en fackman. Hüppe säkerhetsglas med ett glas får inte bearbetas ytterligare efteråt. Man måste alltid se till att skydda glasens kanter, t ex alltid använda trä eller papp som underlag när man ställer ifrån sig glaset.
- SF** **Turvallisuusohje:**
Asennus on suoritettava ammattihenkilön toimesta. Yksilasisia Hüppe-varmuuslaseja ei saa käsitellä jälkikäteen. Suojaa aina lasien reunat; esim. maahan laskettaessa käytä aina puu- tai pahvialustaa.
- SK** **Bezpečnostné pokyny:**
Instaláciu musí previes odborník. Bezpečnostné jednovrstvové sklá Hüppe sa dodatočne nesmú opracovávať. Hrany tabú musia by stále chránené, napr. pre odstavenie tabú pouívajte zakadým drevenú alebo lepenkovú podložku.
- SLO** **Varnostni nasveti:**
Montažo mora opraviti strokovnjak. Varnostne enostenske šipe proizvajalca Hüppe ne smete naknadno obdelovati. Vedno morate zaštititi robove in šipe, npr. e odstavite šipe vzemite vedno les ali karton za podlogo.
- TR** **Emniyet açıklaması:**
Du duvarının bir usta tarafından takılması gereklidir. Hüppe'nin emniyet camından mamül tek katlı levhalarının sonradan ilenmesi yasaktır. Camın kenarlarını, örneğin camı yere koyarken altına tahta veya karton koyarak daima koruyunuz.

RT001-02

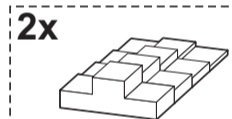
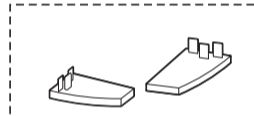
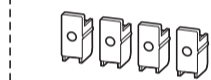
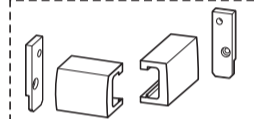
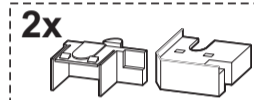
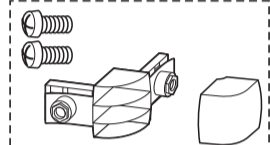
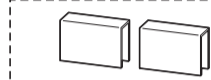
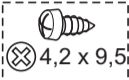
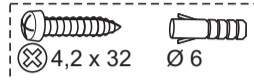
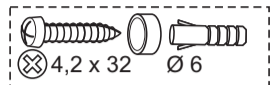
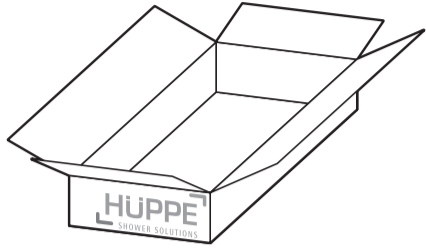
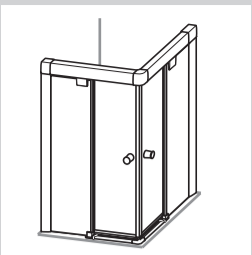

2x

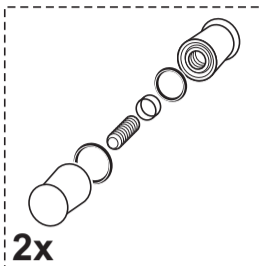

2x

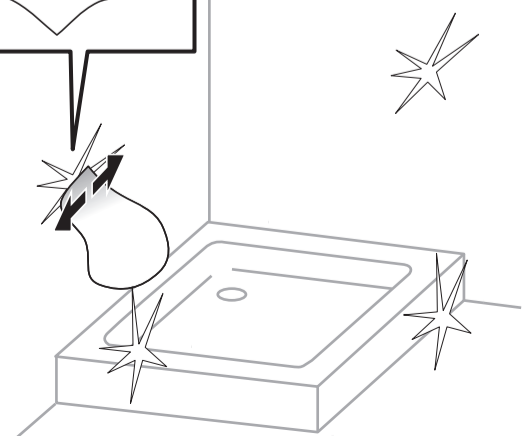
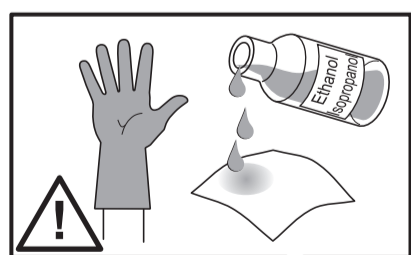
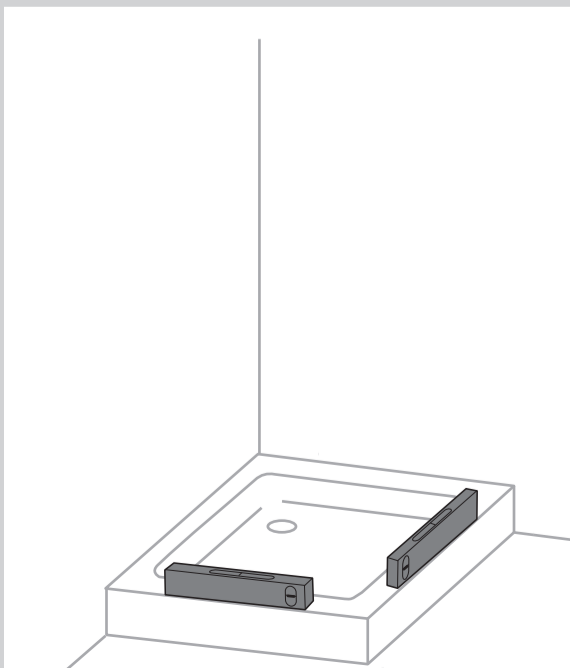
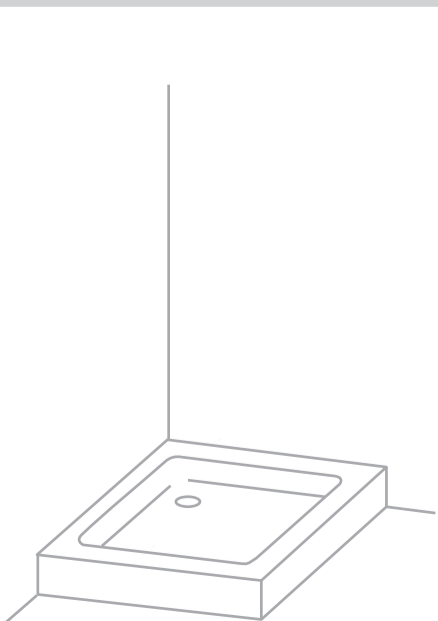
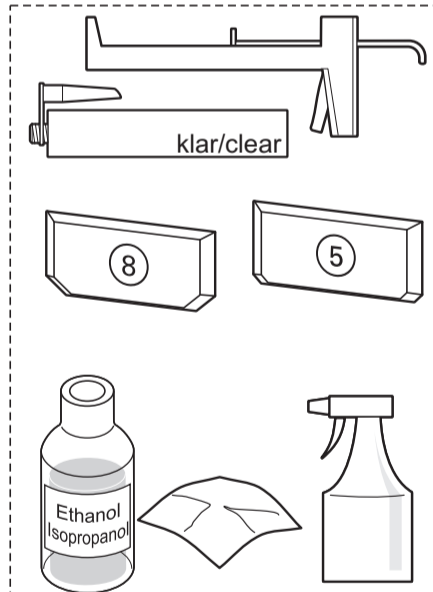
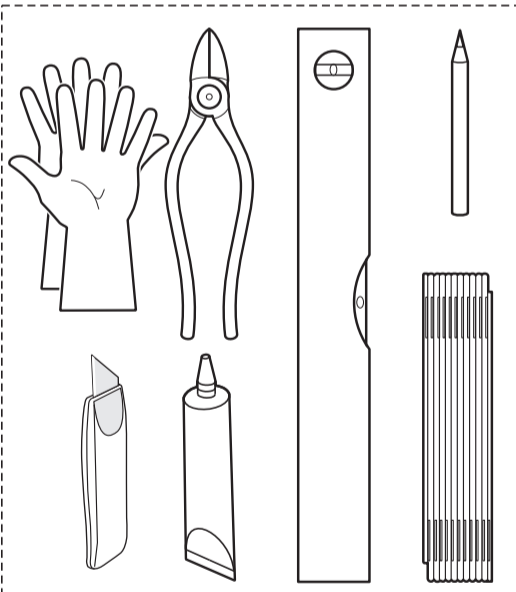
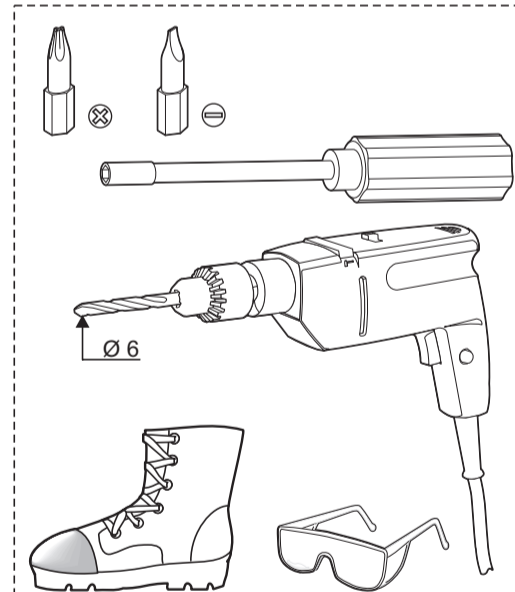
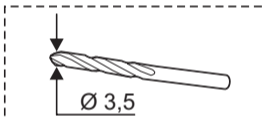
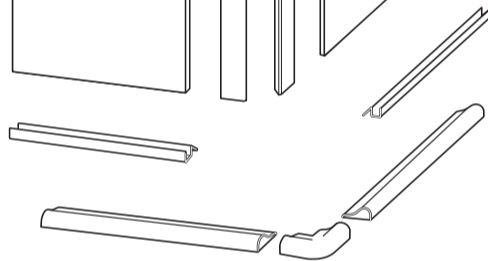
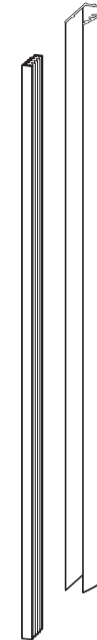
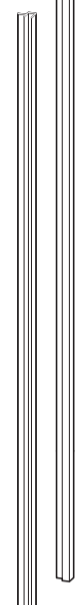
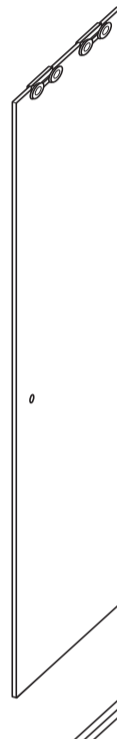
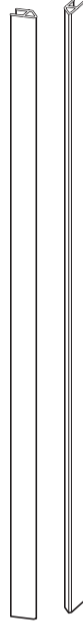
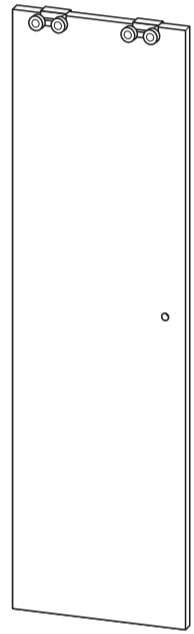
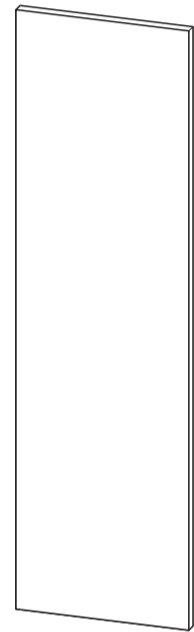
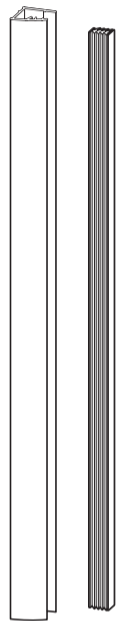
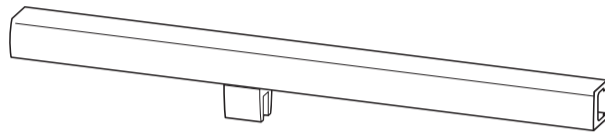

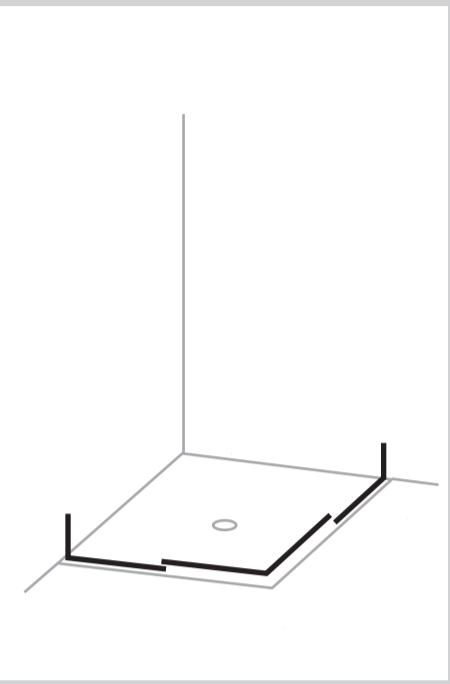
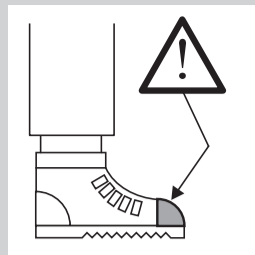
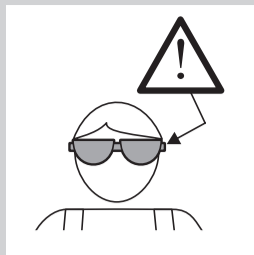
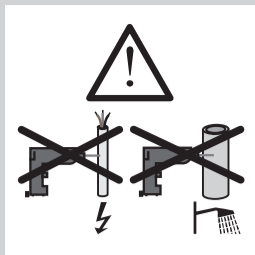
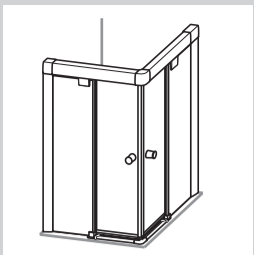

1

X1/X2	Y1/Y2
670 - 674	395
675 - 689	410
690 - 705	415
720 - 724	420
725 - 739	435
740 - 755	440
770 - 774	445
775 - 789	450
790 - 805	465
870 - 874	495
875 - 889	500
890 - 905	515
970 - 974	545
975 - 989	550
990 - 1005	565

